

SPACE

STANDARD FEATURES

- Hard wood frame, seat suspensions in reinforced elastic webbing.
- Seat depth 60 cm - 24".
- Seat height 42 cm - 17".
- Armrest height 55 cm - 22".
- Seat cushions in polyurethane.
- Back cushions in polyurethane.
- Armrest cushions in feather.
- Wood legs height 6 cm - 2" available in Wengé finish.
- Metallic detail in seatings and back cushions are available in the following finishes only: anthracite, brass and brushed chrome.
- Folding bed not available.
- All corner elements and Chaise longue include one C0127 (CUC501B) throw pillow free of charge.
- Stitching CUC 501B.

CARATTERISTICHE STANDARD

- *Struttura in legno e multistrato, molleggio seduta con cinghie elastiche.*
- *Profondità seduta 60 cm.*
- *Altezza seduta 42 cm.*
- *Altezza braccio 55 cm.*
- *Cuscini seduta in poliuretano.*
- *Cuscini schienale in poliuretano.*
- *Cuscini braccio in piuma.*
- *Piedi in legno altezza 6 cm, disponibile in finitura Wengé.*
- *Inseri cuscini seduta e schienale disponibili in finiture: antracite, ottone e cromo satinato.*
- *Inserimento letto non possibile.*
- *Elementi con angolo e chaise longue hanno il cuscino volante C0127 (CUC501B) compreso nel prezzo.*
- *Cucitura CUC 501B.*

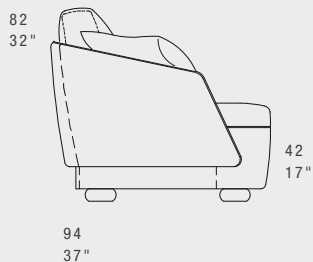

PNO
100 / 39"

LH VERSION RH VERSION

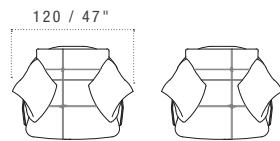
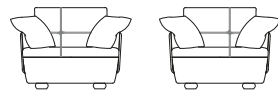

POL (SWIVEL)
100 / 39"

LH VERSION RH VERSION

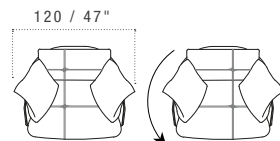
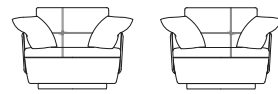

REVOLVING

D2
180 / 71"

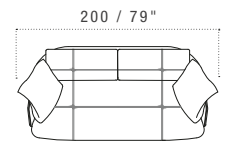
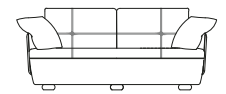

D3
220 / 87"

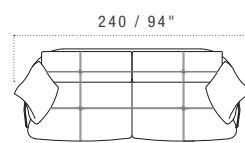
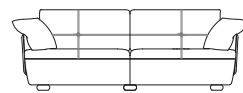

D3M
260 / 102"

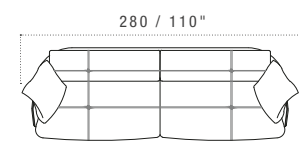
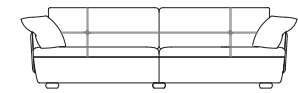

SCH
115 / 45"

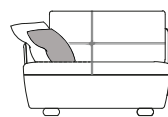

125 / 49"

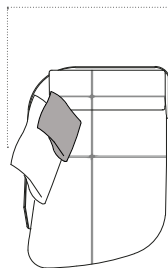

DEPTH 160 / 63"

DCH
115 / 45"

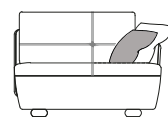

125 / 49"

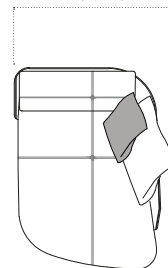

INCLUDED
CUSHION
C0127

S2B
106 / 42"

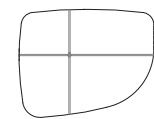
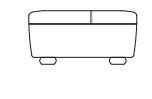
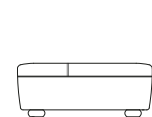

D2B
106 / 42"

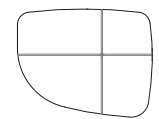
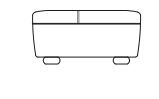
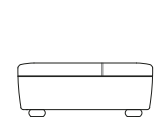

DEPTH 85 / 33"

NOTES

- Dimensions: the first figure shows sizes in centimeters, the second in inches.
- Suggested tables T210B, T211B, T212B, T213B and T214B.
- Suggested pillows C0126 and C0127.
- Coffee table with leather detail on structure (finish specification required).
- Leather insert element can have the same finishing as the upholstery or as the details. Can't be chosen freely.

NOTE

- *Dimensioni: la prima cifra indica i centimetri, la seconda cifra indica i pollici.*
- *Tavolini consigliati T210B, T211B, T212B, T213B e T214B.*
- *Cuscini consigliati C0126 e C0127.*
- *Dettaglio in pelle (finitura da specificare in ordine) su strutture coffee table.*
- *L'inserto in pelle può essere uguale al rivestimento o ai dettagli. Non configurabile a libera scelta.*

ALL ELEMENTS ARE FREESTANDING

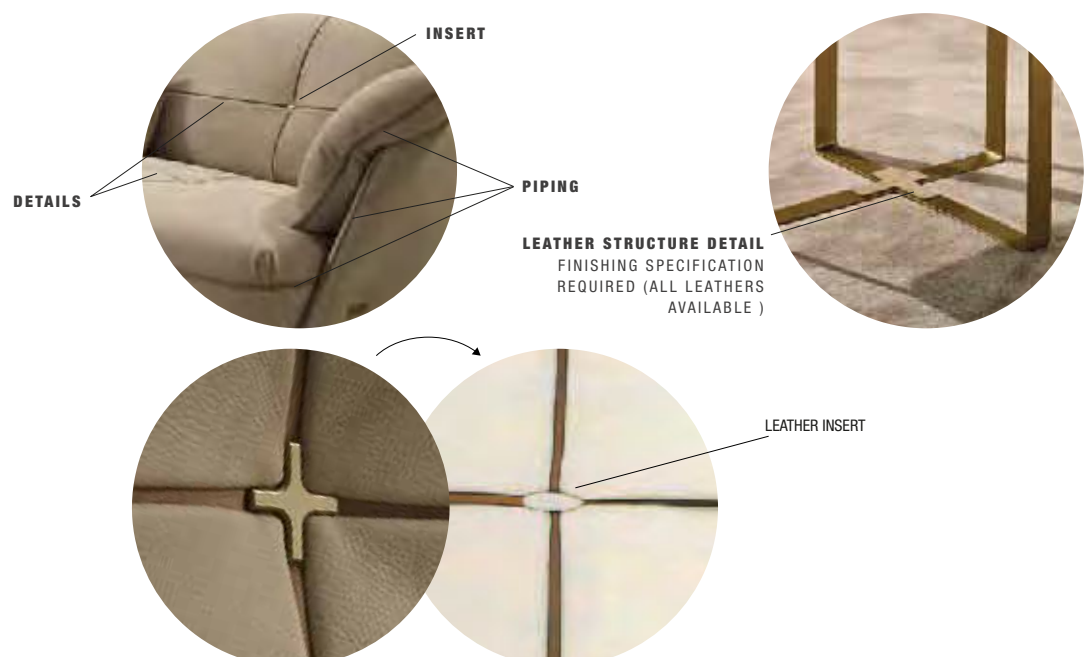

SPACE SOFA'S CROSS INSERT CAN BE REPLACED WITH LEATHER INSERT VARIANT.

SPACE

J all items in group J have the same seat width / tutti gli elementi del gruppo J hanno lo stesso modulo di seduta

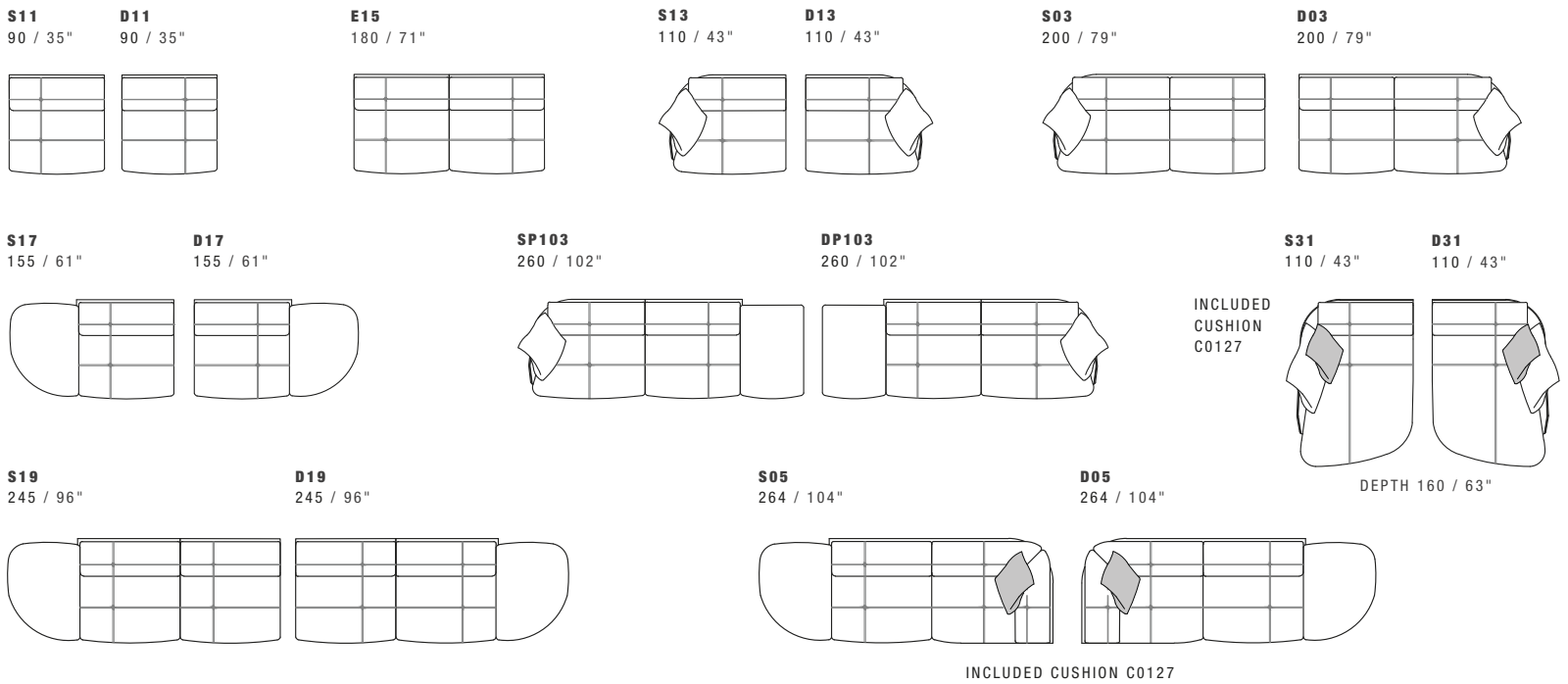

K all items in group K have the same seat width / tutti gli elementi del gruppo K hanno lo stesso modulo di seduta

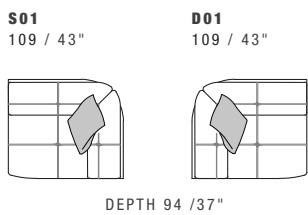
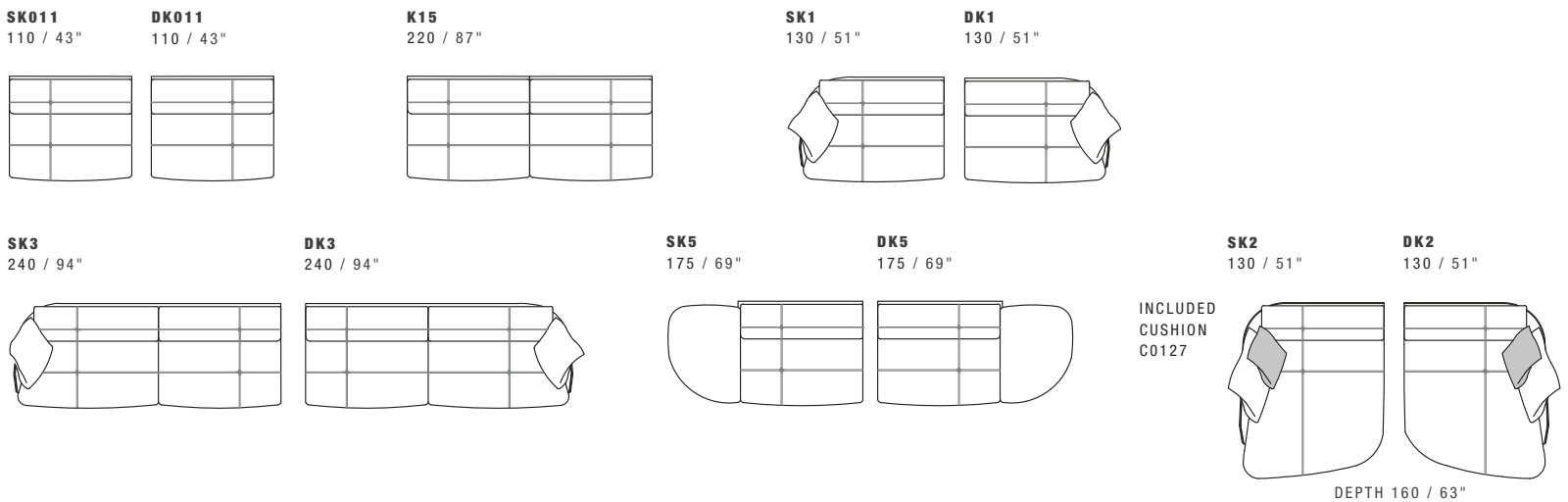

INCLUDED CUSHION C0127

T210B COFFEE TABLE
98X75XH.36 / 39X30XH.14"



T211B COFFEE TABLE
60X60XH.44 / 24X24XH.17"



T212B COFFEE TABLE
110X75XH.36 / 43X30XH.14"



T213B COFFEE TABLE
40X40XH.47 / 16X16XH.19"



T214B COFFEE TABLE WITH WHEELS
72X60XH.30 / 28X24XH.12"



- GLASS - CERAMIC / MARBLE TOP
- METAL BASE AVAILABLE IN ALL GAMMA CUSTOMIZING FINISHES

- GLASS - CERAMIC / MARBLE TOP
- HARD WOOD FRAME AND POLYURETHANE COVERED WITH LEATHER / FABRIC

C0127
SUGGESTED PILLOW
40X40 / 16X16"



C0126
SUGGESTED LUMBAR PILLOW
60X30 / 24X12"

